

Sunny Apex



Features

- Aesthetically using clear surface back-contact cells
- Cells with High conversion efficiency above 24%
- No LID for N-Type cells solar panels
- Anti-PID performance
- Excellent Temperature Coefficient

Electrical Specifications

Model Type	SA-C75
Peak Power (Pmax)	75W
Module Efficiency	19.60%
Maximum Power Voltage (Vmp)	21.3V
Maximum Power Current (Imp)	3.52A
Open Circuit Voltage (Voc)	24.9V
Short Circuit Current (Isc)	3.71A
Power Tolerance	-5% / + 10%
Maximum System Voltage	600V
Normal Operating Cell Temp.	46 °C (+/- 2)

Mechanical Specifications

Cell type	IBC
Number of cells	total 36 cells, 36 cells in series
Weight	5kg [11.02lbs]
Dimensions	700 x 546 x 35mm [27.56 x 21.50 x 1.38in]
Frame	> 15µm clear anodized aluminum
Junction Box	IP 65 waterproof
Cables	4.00mm ² , 900mm
Connectors	MC4 compatible

Temperature Coefficients

Power	-0.3%/K
Voltage	-0.268%/K
Current	0.042%/K

Warranties & Certifications

Warranties	2 years product warranty, 25 years limited power warranty of 80% of the minimum specified power rating
------------	--

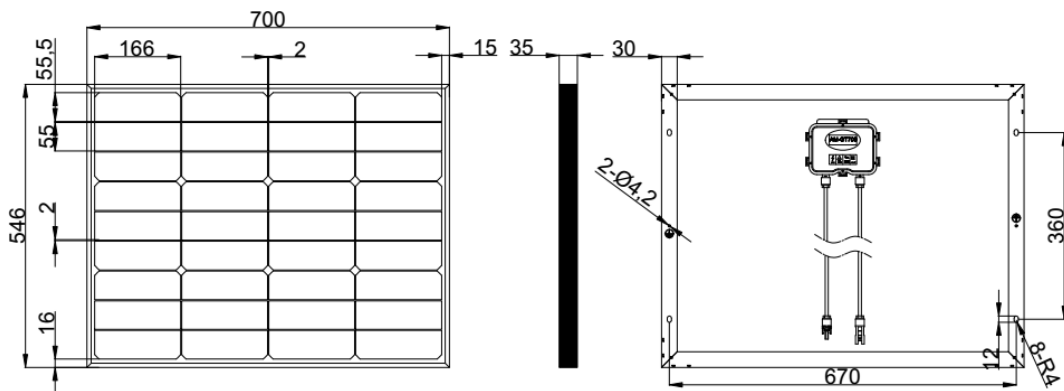

Unit: mm [inch]

Note: All electrical parameters are rated at standard test conditions (irradiance of 1000W/m², AM 1.5G, cell temperature 77°F/25°C)

Caution: Read Safety and Installation Instruction before using this product.

2024 Sunny Apex Development Ltd. All right reserved. Specifications included in this datasheet are subject to change without notice.